

Installation Instructions Shift Improver Kit for 1981-90 THM200-4R Transmission

Part No. 35265

© B&M Racing & Performance Products 1999

Congratulations! You have just purchased the most complete and versatile recalibration kit available for the TH-200-4R transmission. We have endeavored to make the installation instructions on the following pages as clear and complete as possible. Installation of your Shift Improver Kit can be accomplished by anyone with minimum mechanical experience. It is important however to closely follow the instructions. **Read through the instructions completely before beginning the installation.** Read each step carefully before proceeding, if you do not understand, go back and read the step again. **NOTE:** This Shift Improver Kit is not a cure-all for an ailing transmission. If your transmission is slipping or in poor general shape, the installation of this Shift Improver Kit may worsen the condition. However on a properly operating transmission in average condition, the Shift Improver Kit will provide the kind of transmission performance your looking for. **Check the tool list at the end of these instructions for the tools required to install your Shift Improver Kit.**

INTRODUCTION

This kit can be installed in a few hours by carefully following the instructions.

Printed in U.S.A.

Read all instructions first to familiarize yourself with the parts and procedures. Transmission components are precision fit, work slowly and do not force any parts. Burrs and dirt are the number one enemies of an automatic transmission. Cleanliness is very important, so a clean work surface from which oil can easily be removed is necessary.

This kit contains all parts necessary to obtain two different levels of performance, depending on intended use:

1. **Heavy Duty;** For passenger vehicles, towing, police, taxi, or any other heavy duty use. Firm shift feel, perfect for every day street use.
2. **Street;** For full performance street use. Street level produces firm positive shifts and maximum transmission torque capacity.

It is important to install either the heavy duty or street levels. Do not mix modifications from different levels.

When installing your Shift Improver Kit there are several other **B&M** products you may wish to consider:

DRAIN PLUG KIT 80250: TH-200-4R transmissions are not factory equipped with a drain plug. The **B&M** Drain plug kit is inexpensive and easy to install and it helps eliminate the mess during

fluid change or pan removal.

TRANSMISSION OIL COOLER: We feel that it is very important that every vehicle used in a heavy duty application (Towing, RV, Commercial, Police, etc.) should have an oil cooler. Heat is the major causes of transmission failures, and an oil cooler is an inexpensive safeguard against overheating and failure. **B&M** offers a wide range of transmission coolers to suit every need, which are available at your **B&M** dealer.

TEMPERATURE GAGE KIT: 80212 Most transmission and converter failures can be traced directly to excessive heat. The **B&M** transmission temperature gage can save you a costly repair bill by warning you ahead of time of an overheated transmission. The **B&M** temperature gage is extremely accurate and dependable, it comes with all necessary hardware and is easy to install.

DISASSEMBLY

Automatic transmissions normally operate at temperatures between 150 and 250 degrees Fahrenheit. We suggest the vehicle be allowed to cool for several hours before disassembly to avoid burns from hot oil and parts.

The vehicle should be raised so there is at least two feet ground clearance for

9500536-01

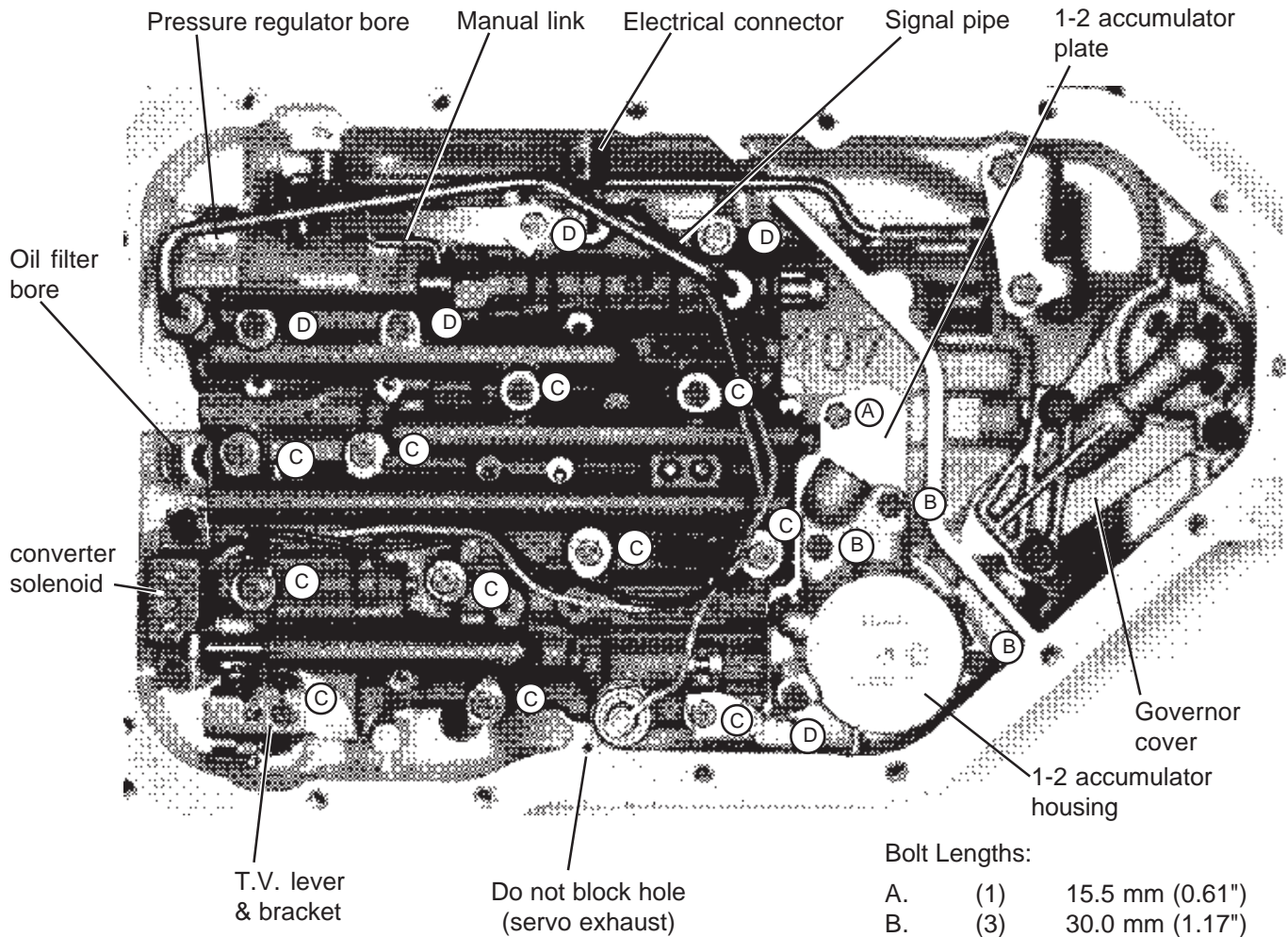

Fig. 1. Valve body and accumulator installed.

Bolt Lengths:

A.	(1)	15.5 mm (0.61")
B.	(3)	30.0 mm (1.17")
C.	(11)	45.0 mm (1.76")
D.	(5)	60.0 mm (2.34")

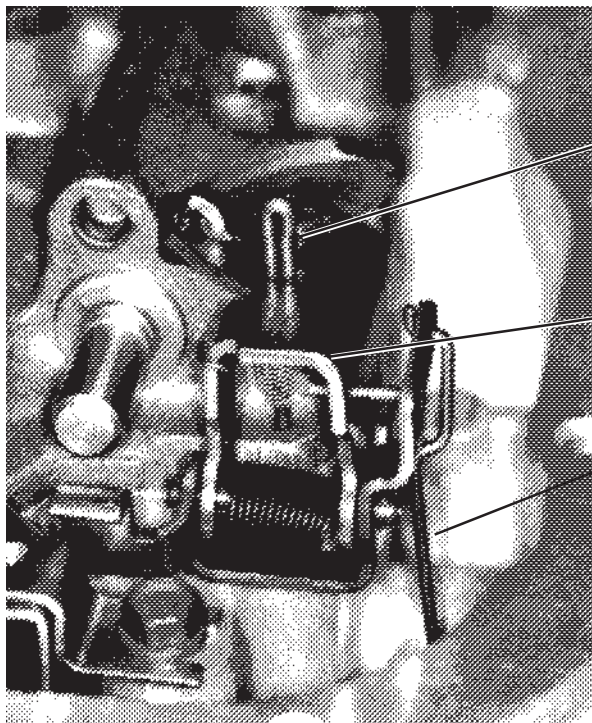

Fig. 2. T.V. Lever and Bracket.

ease of installation and safety. **MAKE SURE THE VEHICLE IS RIGIDLY AND SECURELY SUPPORTED, JACK STANDS, WHEEL RAMP OR A HOIST WORK BEST, DO NOT USE JACKS ALONE.** Have an oil drain pan ready to catch oil and a tray on which to put small parts so they won't go lost.

STEP 1. Position your drain pan beneath the transmission to catch the oil. To remove the oil pan first remove all but three bolts on the right hand side of the pan. Next loosen but do not remove the three remaining bolts. If the pan sticks to the gasket, insert a flat screwdriver between the pan and case and pry down gently to break pan loose. Slowly remove the remaining three bolts allowing the pan to tilt down and drain. Remove all gasket material from the pan and case flange.

STEP 2. Remove the oil filter by gently pulling it straight down. The pickup tube has an O-ring or seal around the

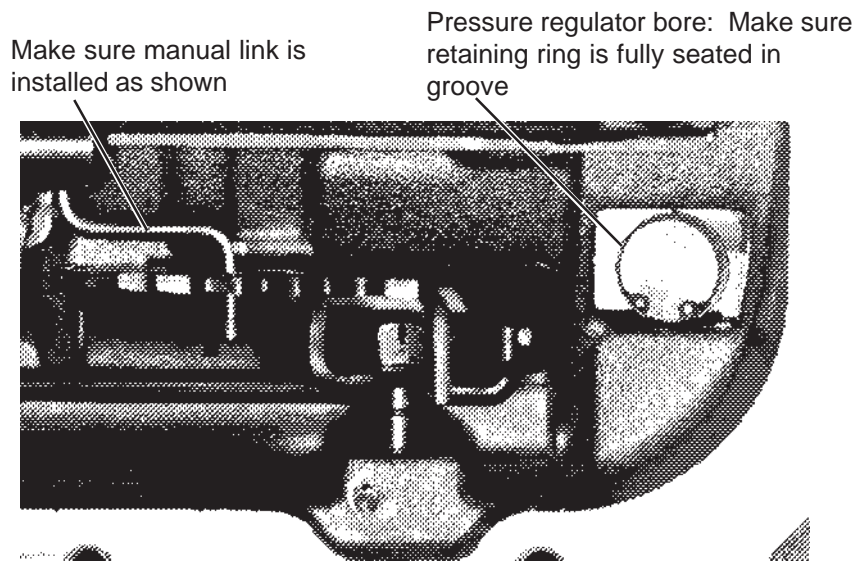

Fig. 3. Pressure Regulator Bore.

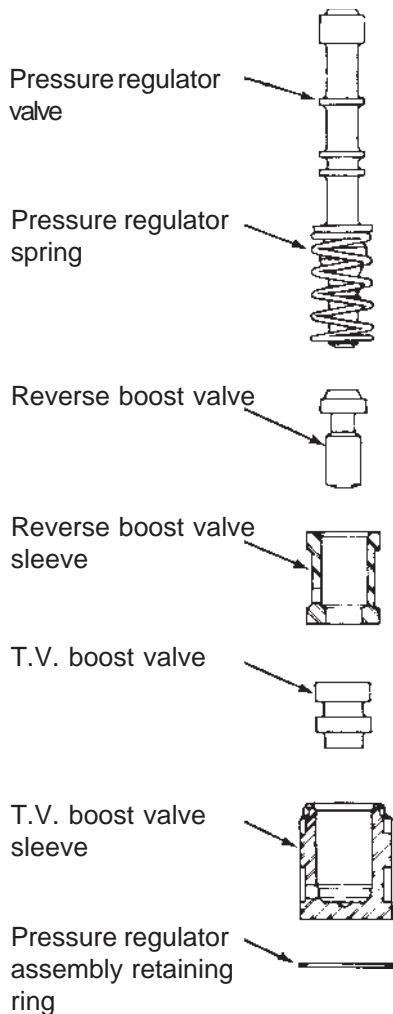

Fig. 4. Pressure Regulator Assembly.

Pressure regulator bore: Make sure retaining ring is fully seated in groove

end that fits into the pump housing. Sometimes the pickup tube O-ring or seal remains in the pump bore, if so remove O-ring or seal from pump.

STEP 3. (See Fig. 1) There are a variety of different wiring harnesses used on the TH-200-4R. Before proceeding further make a sketch and some notes describing your particular unit, recording which connectors go to which switch. Disconnect the T.V. cable connector from the throttle lever on carburetor or throttle body. Remove connectors from switches. Unplug the wiring harness from case electrical connector by prying the lock tab away from the plug and pulling down on the plug, **do not pull on the wires.** Removing solenoid is not required, just tie the wires up out of the way. Remove signal oil pipe, detent spring, and the throttle valve lever and bracket assembly, (see Fig. 2.)

STEP 4. Remove all valve body bolts **except** the center one (See Fig. 1.) Hold the valve body up firmly with one hand and remove the remaining bolt slowly. Lower the valve body and disengage the manual valve link. There are several check balls in the valve body along with several pints of oil. Have your drain pan ready to catch the oil and check balls (should they fall out.) Save all (12) check balls in a safe place where they won't get lost.

STEP 5. Remove the 1-2 accumula-

tor housing and plate while holding the separator plate up to the case. Then slowly lower the separator plate and retrieve the (8) check balls located above the plate. **IMPORTANT:** Make note of the **color, size and location** of the 1-2 and 3-4 accumulator springs for correct reassembly. Remove all old gasket material from these parts.

MODIFICATIONS

STEP 6. All Performance Levels; Pressure regulator. Remove the snap ring at the end of the pressure regulator bore in the oil pump assembly (See Fig. 3.) Use a screwdriver to hold the pressure regulator assembly while removing the retaining ring. If the sleeves stick in the bore, lightly tap the sleeve with a small rod and a mallet (piece of 2X4). Remove two sleeves with valves, the pressure regulator spring and valve. Reassemble the pressure regulator assembly using the **BLUE** spring supplied with the kit (See Fig. 4.) Use the new retaining ring from the kit. **Important:** Make sure the retaining ring is firmly seated in its groove when assembled.

CAUTION: The pressure regulator boost valve train **MUST** be installed in the proper order with the sleeves and valves oriented as shown. There are several ways the sleeves and valves can be installed, however, only the orientation shown will work properly. Improper installation will cause low line pressure, resulting in slipping clutches and burnt friction elements.

STEP 7. Heavy Duty and Street; Separator Plate. Using the supplied drills, enlarge the holes in your separator plate as indicated (see Fig. 5) for the performance level desired. Pay close attention to the diagram when locating the holes to be enlarged so as not to enlarge the wrong hole. Carefully deburr the holes after drilling.

STEP 8. Street Level Only; Line bias valve. Rinse off valve body with clean solvent to remove any dirt or grit. Move to a clean working area. The valve body consists of precision fit components which will not tolerate dirt or burrs. Remove the roll pin retaining the line bias valve (See Fig. 6.) Remove the aluminum plug, valve and spring from bore. The stock spring will not be re used. Insert the RED spring from the kit

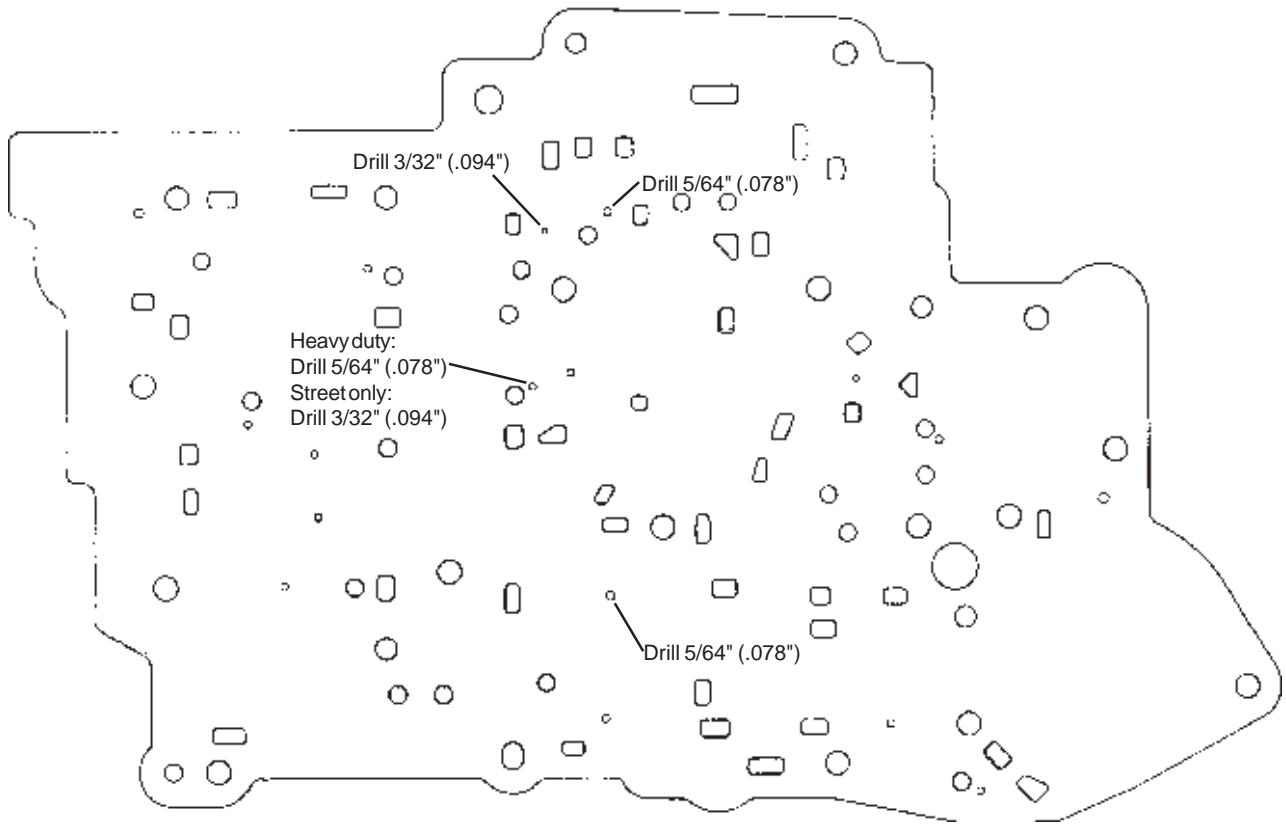

Fig. 5. Drill Separator Plate.

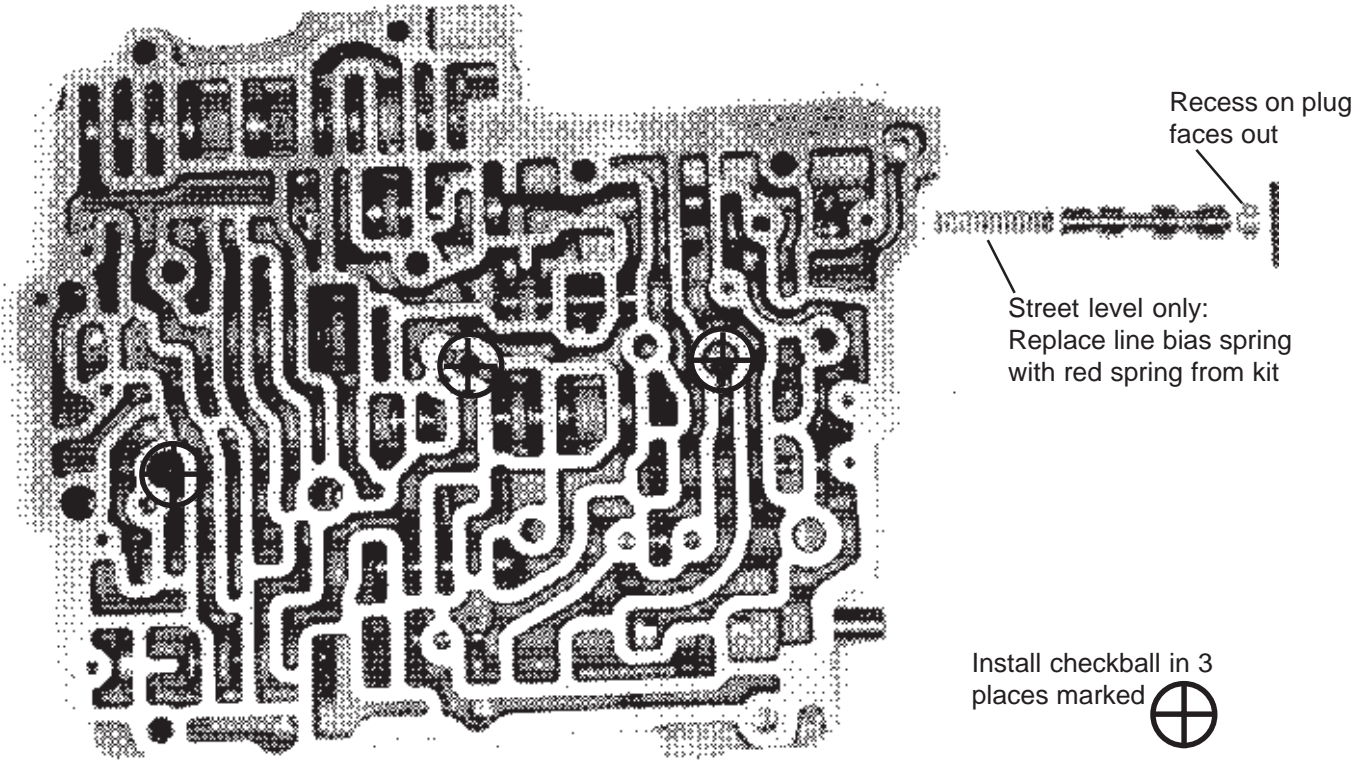
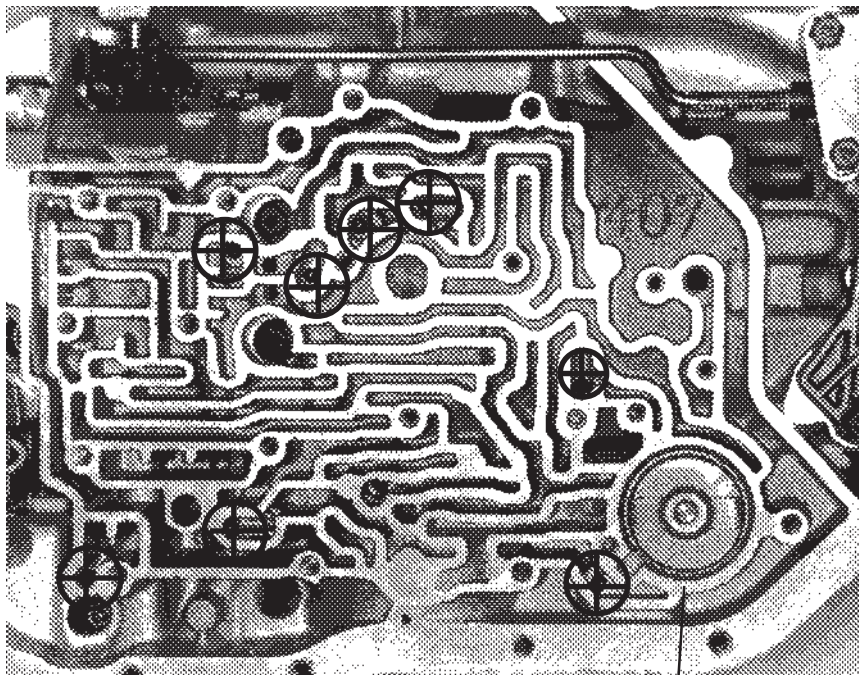

Fig. 6. Valve Body Checkball Placement.



Place checkballs in the 8 locations marked

3-4 accumulator



Fig. 7. Case Checkball Placement.

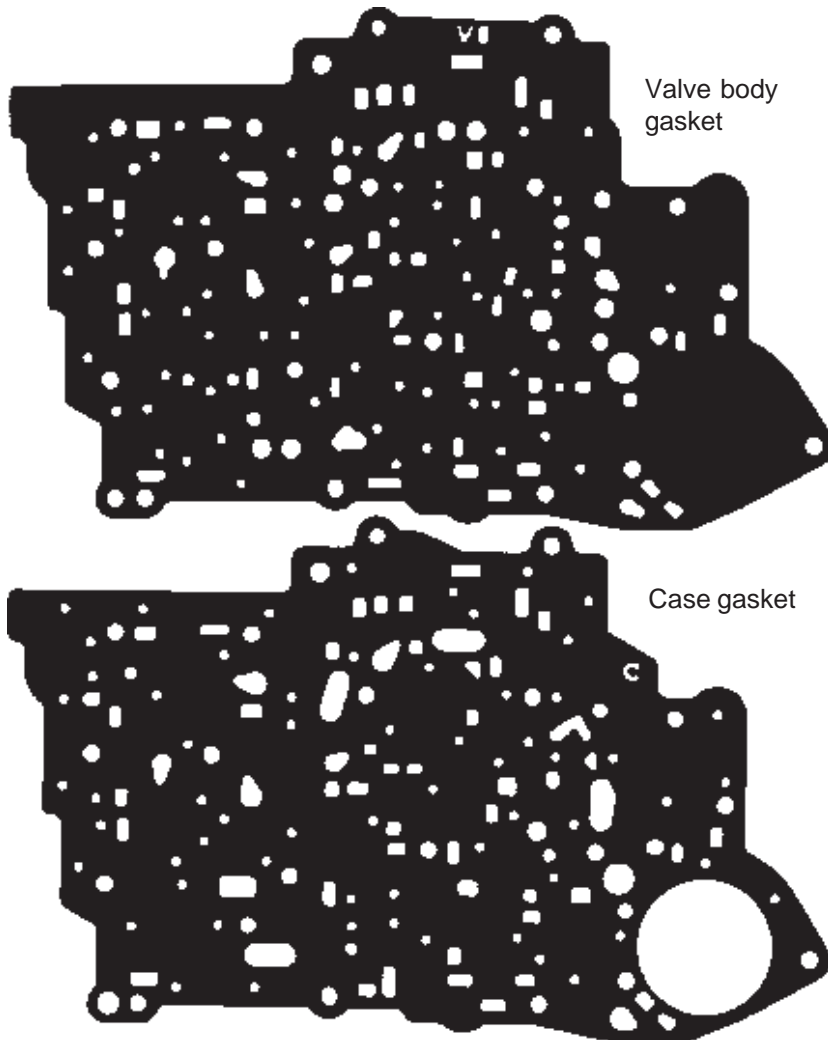

Fig. 8. Valve Body Gaskets.

into the bore then install the valve, aluminum plug, and roll pin in reverse order of removal. **Important:** Do Not dry or wipe parts with cloth rags because the lint and loose threads can contaminate the transmission fluid and result in jammed pressure regulator and shift valves. Clean valve body and separator plate with clean solvent and air dry.

ASSEMBLY

STEP 9. Heavy Duty and Street; Check ball placement (See Figs. 6 & 7) Place check balls in the valve body and case in the positions shown. Use a dab of grease or petroleum jelly to hold check balls in position. There are (3) check balls located in the valve body and (8) in the case.

STEP 10. Place the new separator plate gaskets on the separator plate (See Fig. 8.) Use a dab of grease or petroleum jelly to help hold the gaskets to the plate. The gasket with the 'C' cut in it goes next to the **case** and the gasket with the 'V or VB' cut in it goes next to the **valve body**. Make sure no holes in the separator plate are **covered** by the gasket. If your gaskets become damaged anytime during the installation of the kit, **replace them**. Purchase OEM gaskets for your **specific** year and model vehicle.

STEP 11. Heavy Duty Level Only; Insert the 3-4 accumulator pin in the case. Over the pin place the spring and then the accumulator piston. Use a dab of grease or petroleum jelly to hold components in place (See Fig. 9.)

STEP 12. Street Level Only; Insert the 3-4 accumulator pin in the case. Over the pin place the **Red** (3/8") spacer, spring and accumulator piston. Use a dab of grease or petroleum jelly to hold components in place (See Fig. 10.)

STEP 13. With the 3-4 accumulator components and case check balls in place, place the separator plate - gasket assembly up to the case followed by the 1-2 accumulator plate. Carefully line up the gaskets and install the short accumulator plate bolt. Tighten bolt finger tight (**Note:** When installing valve body and accumulator housing install all bolts finger tight first to allow the separator plate and gaskets to properly line up before attempting to torque them.

STEP 14. Heavy Duty Level Only;

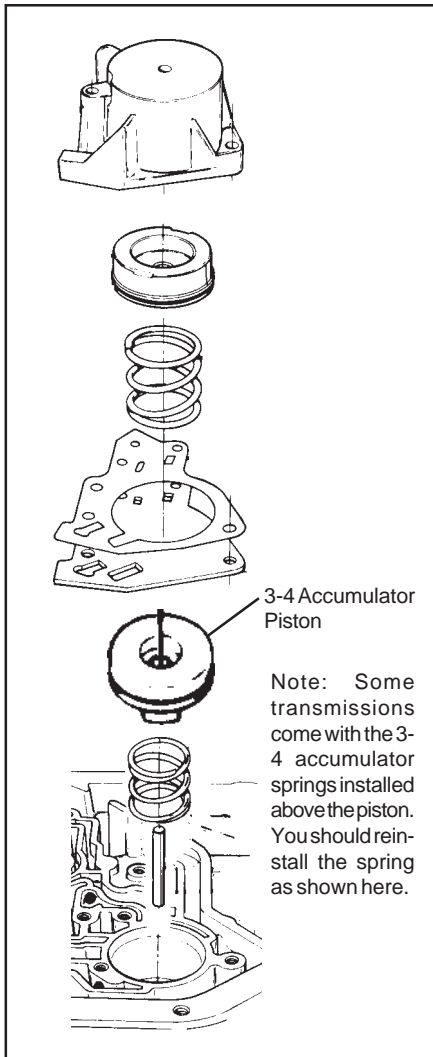

Fig. 9. Heavy Duty Level Accumulator Assembly Order.

Install gasket, piston, spring and 1-2 accumulator housing in reverse order of removal. Tighten bolts finger tight (See Fig. 9.)

STEP 15. Street Level Only; Remove the spring and piston from the 1-2 accumulator housing (See Fig. 10.) and install the **Blue** (3/4") spacer over the guide pin. Install piston and spring into 1-2 accumulator housing in reverse order of removal. With the spacer installed it will be necessary to compress the accumulator spring when installing the accumulator assembly. To help keep the separator plate and gaskets aligned thread 5 or 6 bolts into the case at various positions. Place gasket on accumulator housing then hold the 1-2 accumulator assembly up to the case. As an assembly aid use two of the long valve body bolts as guides while compressing the accumulator spring. To avoid stripped threads make sure bolts are fully engaged before attempting to

draw the accumulator up to the case. **STEP 16. Valve body installation.** Make sure check balls are in proper locations. Position the manual valve so the link rod can be engaged (See Fig. 1.) Do not force the manual valve at any time. When the link and manual valve are fully engaged, align the valve body and case holes then install one bolt finger tight to hold valve body in place. **Important:** Make sure the manual valve link is located as shown.

STEP 17. Install the throttle valve (TV) linkage onto the valve body as shown, make sure the T.V. exhaust checkball lifter rod is correctly assembled. (See Fig. 2.) **IMPORTANT NOTE:** The T.V. cable **MUST** be reset before operating vehicle refer to **step 22.**

STEP 18. Carefully insert ends of the signal oil pipe in their respective bores and push them in evenly until fully engaged. Engage all of the remaining bolts to finish lining up the separator plate and gaskets (See Fig. 1.) Tighten all the valve body and accumulator bolts to 11 NM (8 Ft. Lb.) Avoid stripped threads, Do not over tighten bolts.

Reconnect wiring harness connectors to the terminals from which they were removed. Refer to sketch or notes made at **Step 3.** Reconnect the harness to the case connector making sure it is firmly seated and locked.

STEP 19. Double check installation: 1: make sure all bolts are installed and torqued. 2: Throttle valve linkage operates freely. 3: TV exhaust checkball (#5) lift pin is properly installed. 4: Wiring properly connected. 5: Regulator valve retaining ring fully seated in groove. Place O-ring or seal on the end of the filter tube. Coat the O-ring or seal with clean ATF and push the tube into the pump bore until it is fully seated. The filter retainer clip should be located at the small depression in filter housing.

STEP 20. Remove all old pan gasket material from pan and case pan rail. Clean inside of pan with solvent. You may want to install a **B&M Drain plug kit (80250)** at this time. Install the new pan gasket on the pan and align the holes. Use grease or petroleum jelly to help hold the gasket in place during installation of pan. **Do not use any gasket sealer or silicone compounds.** To prevent premature band failure make sure the servo exhaust hole shown in

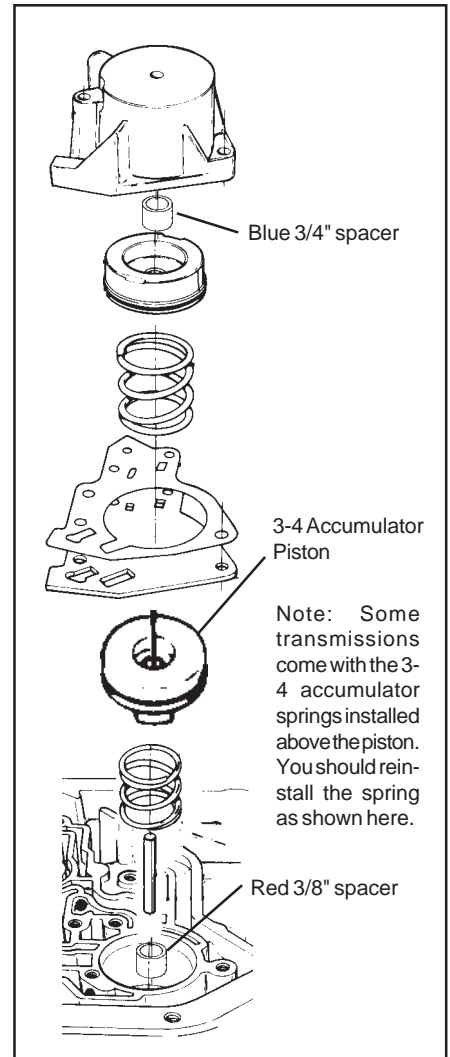

Fig. 10. Street Level Accumulator Assembly Order.

(Fig. 1) is not obstructed. Place pan up to case, align holes and install all bolts finger tight. Tighten bolts to 14 NM (10 Ft. Lb.) Do not over tighten bolts. If the bolts are over tightened the gasket will deform excessively and result in oil leaks.

STEP 21. Fill transmission with fresh automatic transmission fluid to the full mark on the dip stick. You will need about 6 quarts.

STEP 22. You must reset the TV cable, See Fig. 11 for the correct procedure. Failure to reset the TV cable will result in poor shift quality and, or transmission failure.

STEP 23. Inspect the transmission for leaks with engine running. Lower vehicle and check fluid level again adjusting level as required. Test drive vehicle and recheck for leaks while transmission is hot.

TROUBLE SHOOTING

Most problems can be traced to

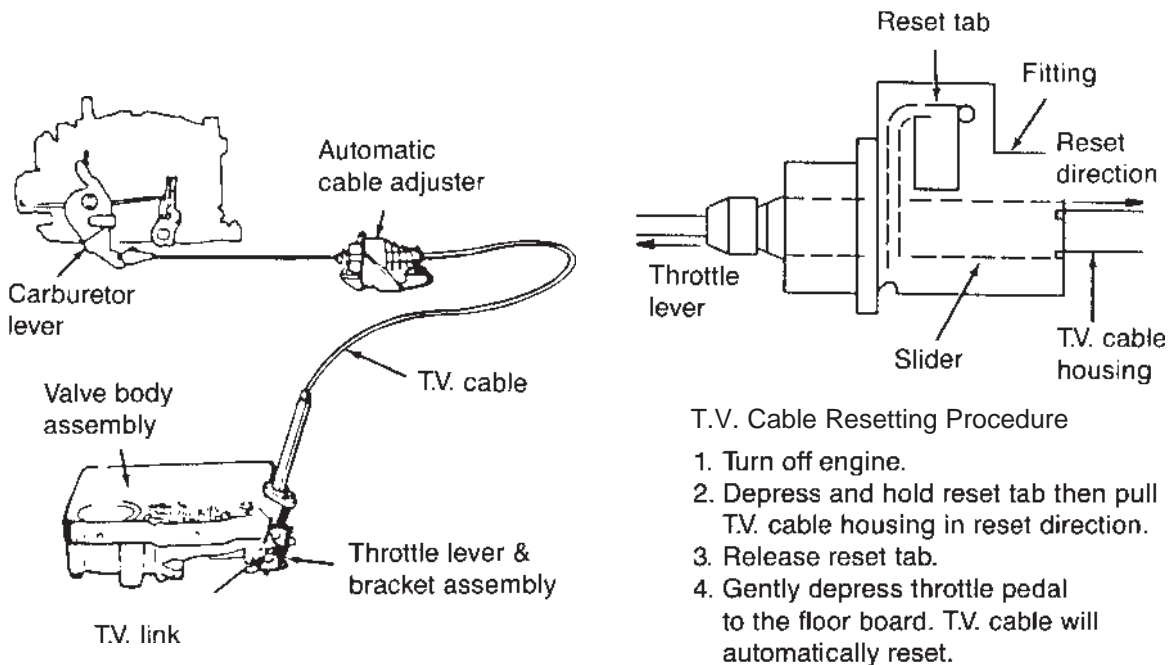

Fig. 11. T.V. Cable Adjustment Procedure.

incorrectly installed components. If the transmission makes unusual noise or feels as if it is binding up, turn off the engine immediately. Go back and recheck the entire installation.

If the problem is shift quality (slipping, hard, early, late) then do the following:

1. Check transmission oil level.
2. Check and adjust T.V. Cable.
3. Check outside manual shift linkage.

If the above does not remedy the problem, then perform the following diagnostic oil pressure check:

1. CHECK ENGINE TUNE
2. INSTALL A 0-2,080 kPa (0-300 PSI) OIL PRESSURE GAGE. THE LINE PRESSURE TAP IS LOCATED JUST ABOVE THE OUTSIDE MANUAL LINKAGE ON THE LEFT HAND SIDE OF THE CASE.

Check oil pressures as follows:

Minimum T.V. Line Pressure Check:

Set the T.V. cable (See Fig. 11) With the brakes applied, take the line pressure readings at the selector lever position and engine R.P.M. specified in the chart.

Maximum T.V. Line Pressure Check:

With the brakes applied, hold or tie the T.V. cable in it's fully extended position then take the line pressure readings again at the selector lever positions and engine R.P.M. specified in the chart.

IMPORTANT: Only pull out T.V. cable for this test. DO NOT open throttle to

wide open position.

Basic line pressure is controlled by the pumps output volume and the pressure regulator valve. The T.V. system which is controlled by the T.V. cable causes line pressure to increase with increased throttle opening. Because of system requirements line pressure is boosted by the reverse boost valve and sleeve assembly when the selector is in the Reverse, D2 or D1 position.

If the oil pressure readings are low, high or do not change when the T.V.

cable is extended (except in D2 & D1 where pressure should remain constant) then look at the pressure regulator assembly for sticking valves or incorrect order of assembly.

TOOL LIST	PARTS LIST
Hydraulic jack	Pressure Regulator Spring (Blue)
Gasket Scraper	Ring Retaining
Jack stands or Wheel ramps	Spring Line Bias (Red)
3/8" Drill motor	Gasket, Valve body upper
Oil drain pan	Gasket, Valve body lower
Fine cut flat file	Gasket, Accumulator
3/8" drive ratchet wrench	Gasket, Oil pan
10mm, 13 mm, Sockets	Spacer, 3/8" (Red)
Wet or Dry sand paper	Spacer, 3/4" (Blue)
Grease or petroleum jelly	Drill, 3/32" (.094)
Small punch or scribe	Drill, 5/64" (.078)
Torque wrench	
Small flat screwdriver	
Internal retaining ring pliers	
Funnel	

TH200-4R TRANSMISSION OIL PRESSURE *

RANGE	OIL PRESSURE AT MINIMUM T.V.		OIL PRESSURE AT FULL T.V.	
	kPa	PSI	kPa	PSI
PARK & NEUTRAL @ 1000 RPM	517	75	758	110
REVERSE @ 1000 RPM	634	92	1380	200
DRIVE (D4) & MANUAL THIRD (D3) @ 1000 RPM	517	75	758	110
MANUAL SECOND (D2) & LOW (D1) @ 1000 RPM	772	112	772	112

* DUE TO THE LARGE VARIETY OF PRESSURE REGULATOR COMPONENTS USED IN DIFFERENT PRODUCTION MODELS OF THE TH200-4R TRANSMISSION THE OIL PRESSURES LISTED ABOVE ARE MINIMUM VALUES. IN MOST CASES THE PRESSURE READING WHICH YOU OBTAIN WILL BE SUBSTANTIALLY HIGHER. FOR A MORE ACCURATE ESTIMATE CONSULT THE APPROPRIATE FACTORY SERVICE MANUAL FOR YOUR MODEL AND YEAR TRANSMISSION.

TROUBLE SHOOTING GUIDE FOR THE HYDRAMATIC TH-200-4R TRANSMISSION

SLIPS	<ul style="list-style-type: none"> -Valve body bolts loose -Low fluid level -1-2 and/or 3-4 accumulator seals missing or damaged. -1-2 accumulator housing bolts loose -Pressure regulator valve assembly improperly installed. -Throttle valve linkage incorrectly installed. -TV cable improperly set -Throttle valve sticking. -Misaligned or interchanged valve body gasket. -Filter O-rings damaged or missing. 	PUMP BUZZ OR WHINE	<ul style="list-style-type: none"> -Low oil level. -Filter tube O-ring cut or missing. -Filter clogged.
OVERHEATING, FOAMING OIL AT DIP- STICK OR BREATHER	<ul style="list-style-type: none"> -Oil cooler has insufficient capacity. -Oil cooler plugged. -High fluid level. 	SOFT 2-3 SHIFTS	<ul style="list-style-type: none"> -Pressure regulator valve assembly incorrectly installed. -TV cable not set properly.
ERRATIC SHIFTING	<ul style="list-style-type: none"> -Shifter not properly adjusted. -Manual valve not properly engaged. -Low fluid level. -Valve body gaskets damaged or incorrectly installed -TV cable binding or improperly set. 	WILL NOT MOVE	<ul style="list-style-type: none"> -Check balls missing or mislocated. -Manual valve not properly engaged. -Accumulator piston(s) left out or seals damaged. -Pressure regulator retaining ring did not seat in groove.
LATE HARD SHIFTS	<ul style="list-style-type: none"> -Valve body gaskets incorrectly installed -TV cable binding or improperly set. 	NO CONVERTER CLUTCH APPLY	<ul style="list-style-type: none"> -Voltage not reaching solenoid. -Harness plug not fully engaged. -Connectors not on correct switches. -Wires pinched and grounded out. -Converter clutch valve stuck.
WILL NOT SHIFT	<ul style="list-style-type: none"> -Check balls missing or mislocated. -Governor failure. -TV cable not properly set. -TV exhaust checkball (#5) lifter, binding, missing or unhooked. 	NO CONVERTER CLUTCH RELEASE	<ul style="list-style-type: none"> -Converter clutch apply valve stuck open.
		NO PART THROTTLE DOWN SHIFT	<ul style="list-style-type: none"> -TV cable not set properly. -Throttle valve binding.
		NO REVERSE AND SLIPS IN FORWARD RANGES	<ul style="list-style-type: none"> -Pressure regulator valve assembly incorrectly installed. -Pressure regulator retaining ring did not seat in groove.